

# FRIEZES

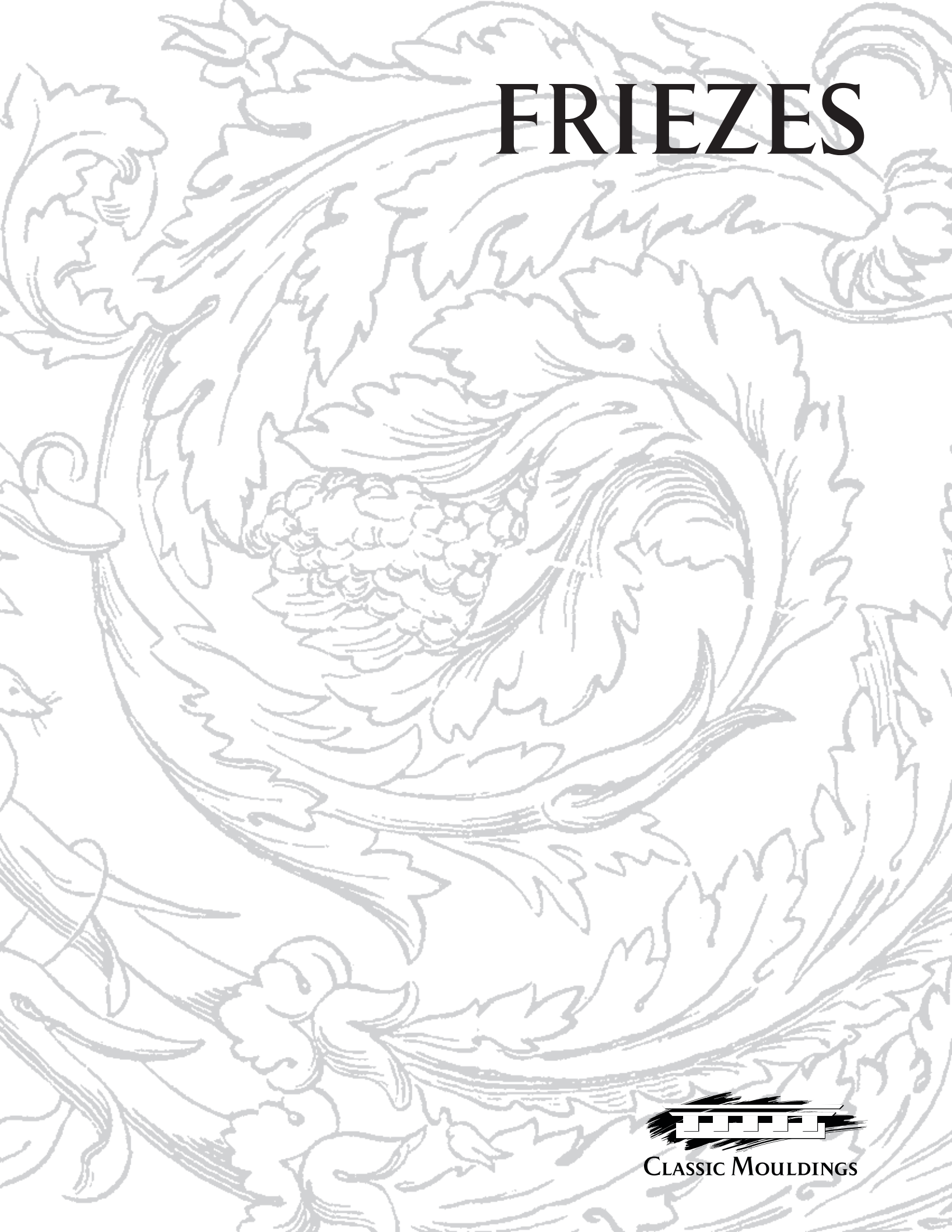

# NEW PRODUCT DESIGNS, SPECIFICATION SHEETS AND CAD FILES

## New Product Designs

New designs are created on regular basis, the best way to present them is through our product catalogue which gets updated on a quarterly basis.

This is an ongoing project and will include old and new items presented with a 3D image to give you and your client, a clearer picture than what is currently seen in the brochures.

Many Architects and Designers may find this useful and alleviate the need for physical samples. If a physical sample is needed we would be happy to accomodate, give us a call at 1-866-745-5560 or email us at [info@classicmouldings.com](mailto:info@classicmouldings.com).

Please note: there may be a cost associated with the production and/or delivery of samples.

## CAD Files

All items item in this product catalogue have a CAD file available for approved clients. If you would like to request a CAD file call us at 1-866-745-5560 or e-mail us at [e-spec@classicmouldings.com](mailto:e-spec@classicmouldings.com). At this time CAD files are not available directly from our website.

## Custom Design

If you cannot find a suitable design or size, in either our brochures or product catalogues, please contact us directly. We would be happy to custom manufacture a part that meet your specific needs.

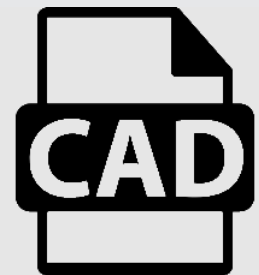
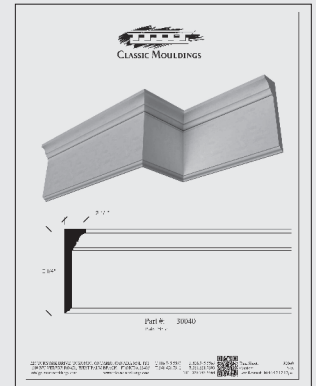



CLASSIC MOULDINGS

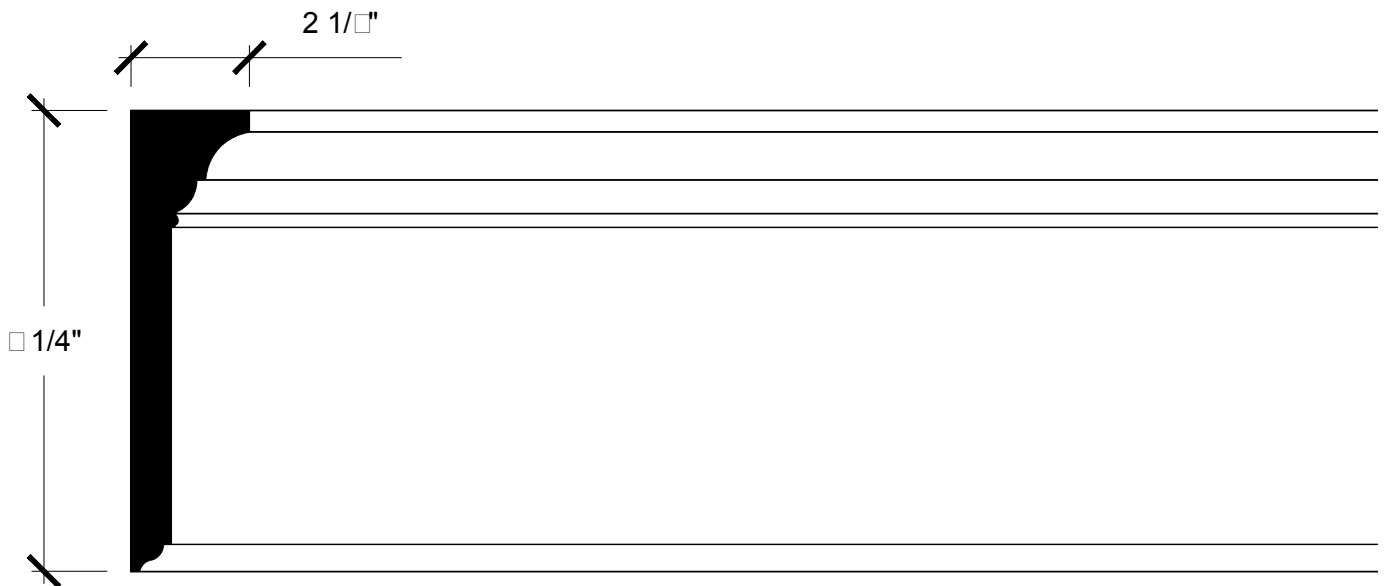
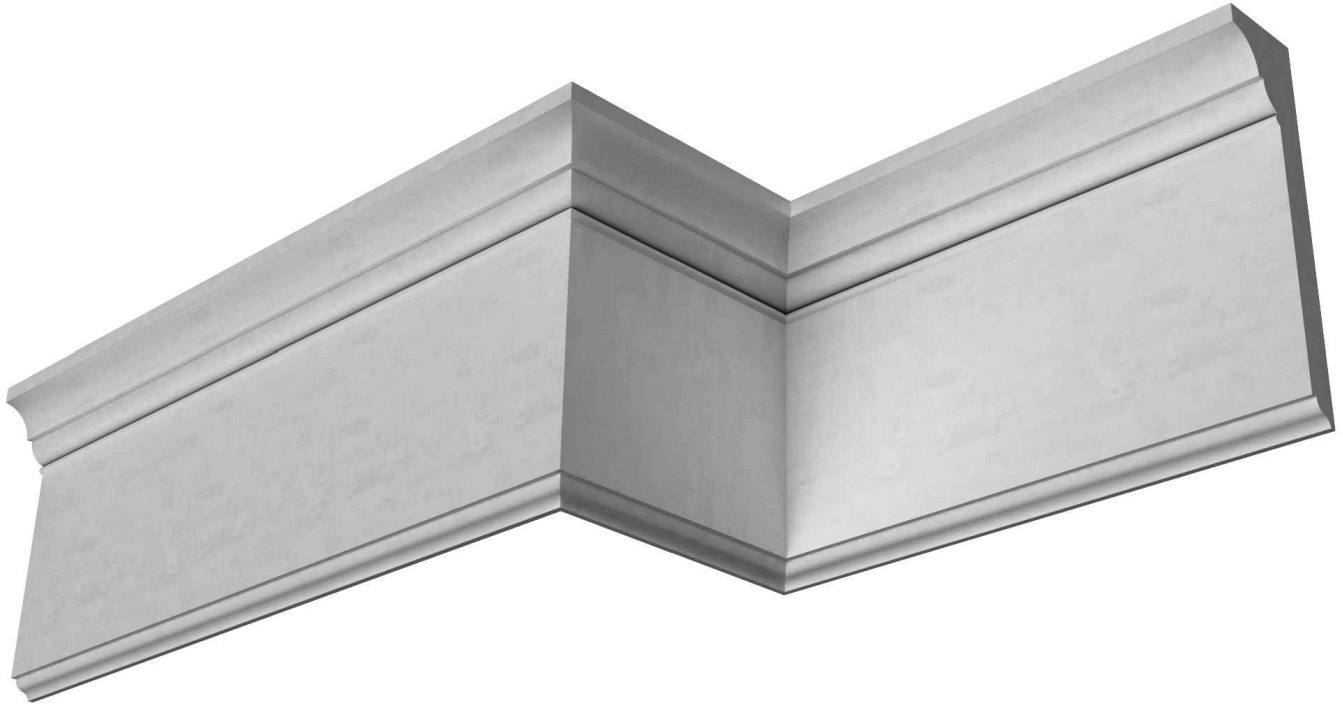

Part #: 30040  
Plain Frieze





# CLASSIC MOULDINGS

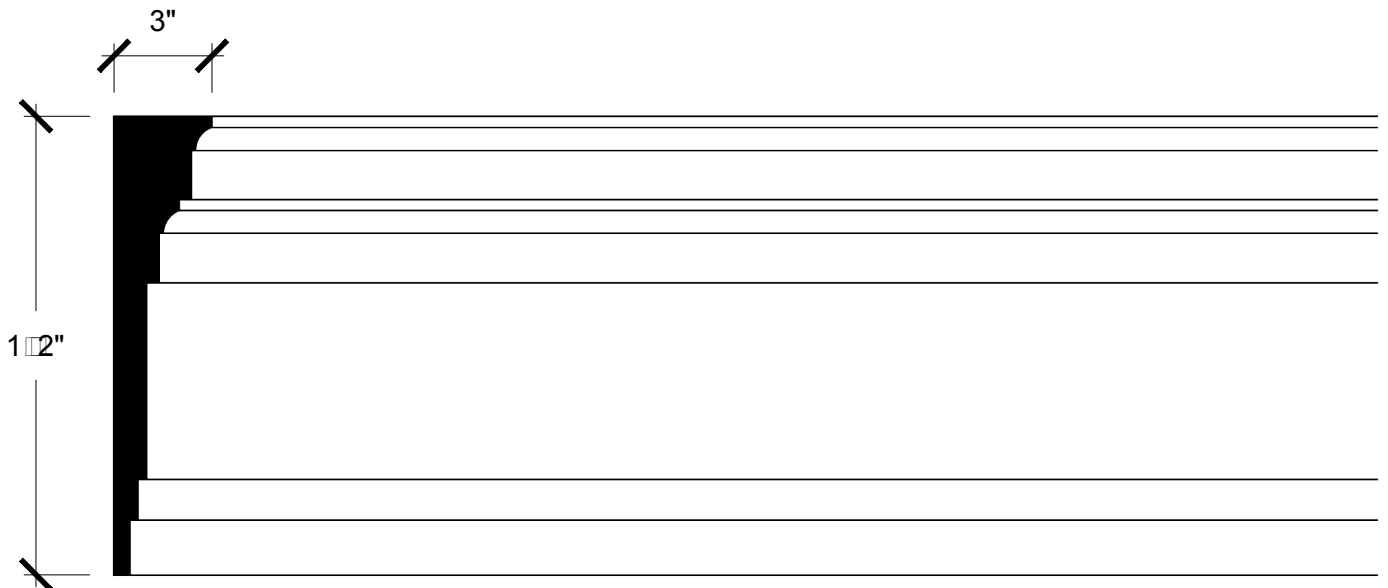
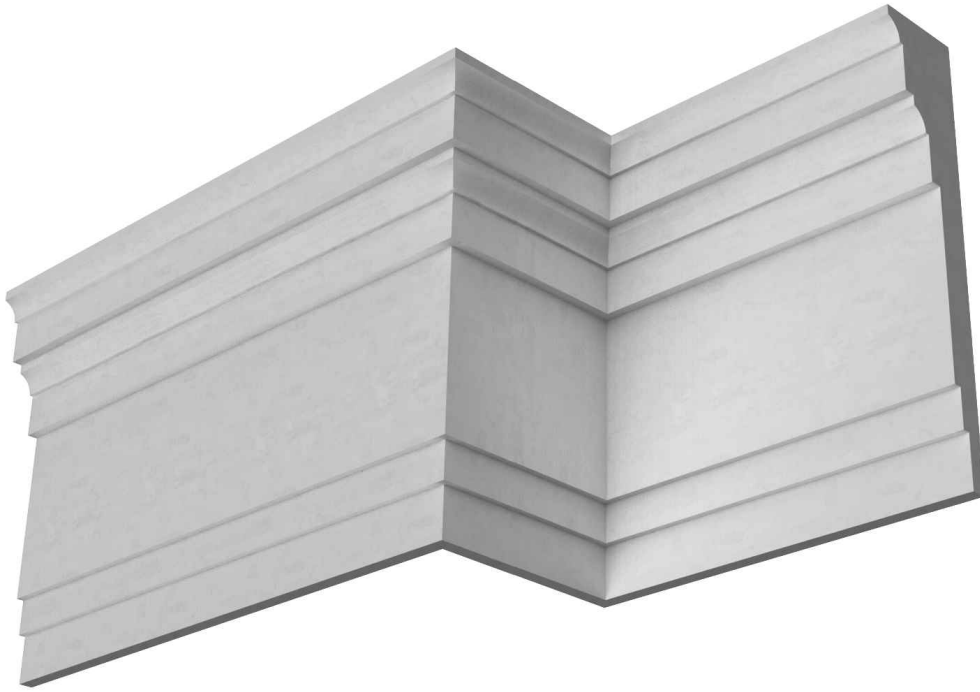

Part #: 30050

Plain Frieze





# CLASSIC MOULDINGS

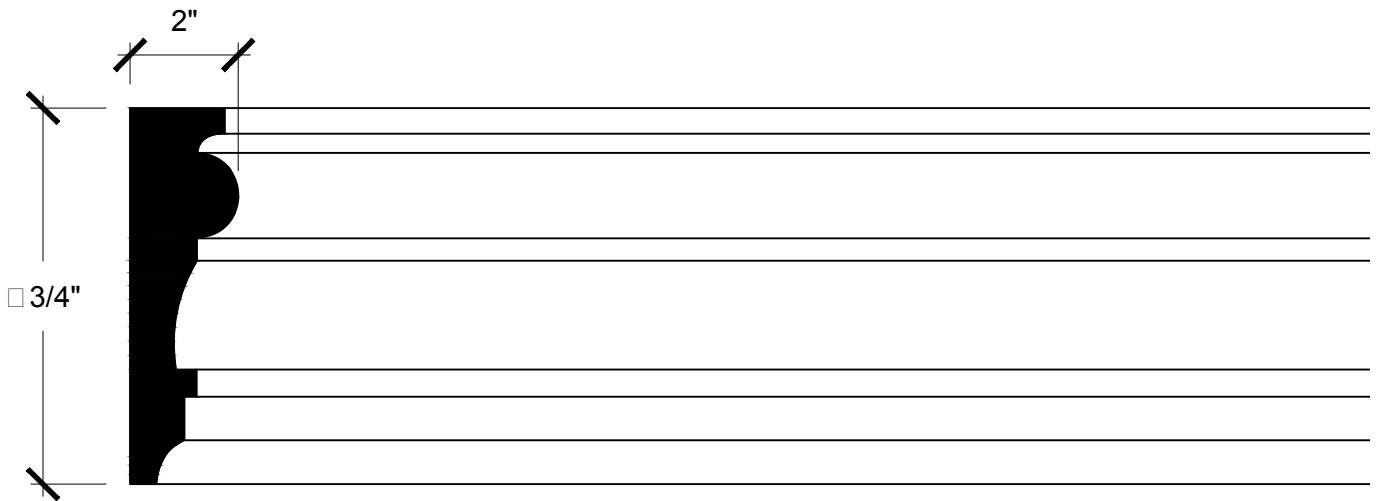
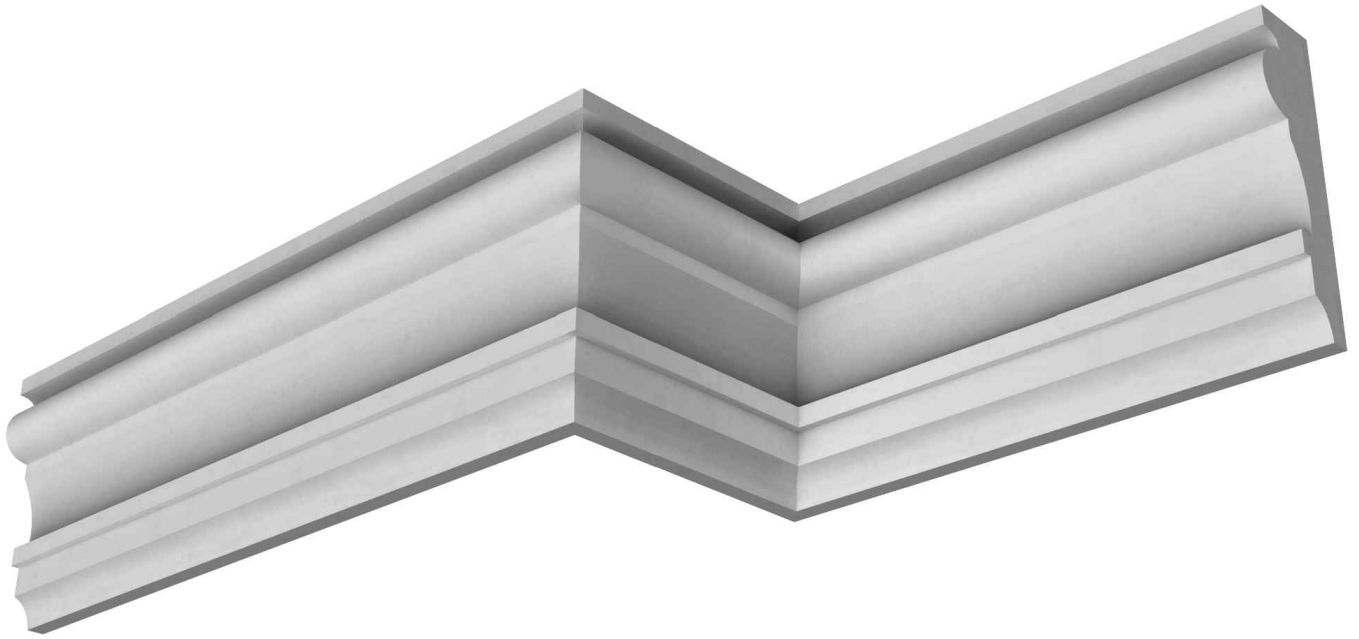

Part #: 30090

Plain Bullnose Frieze





CLASSIC MOULDINGS

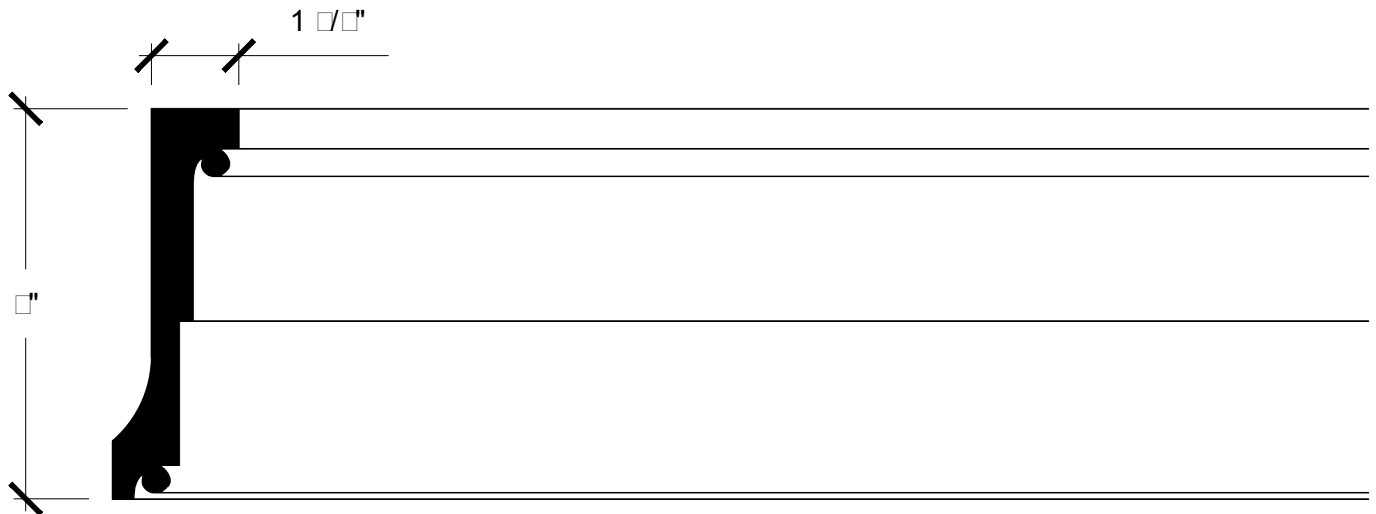
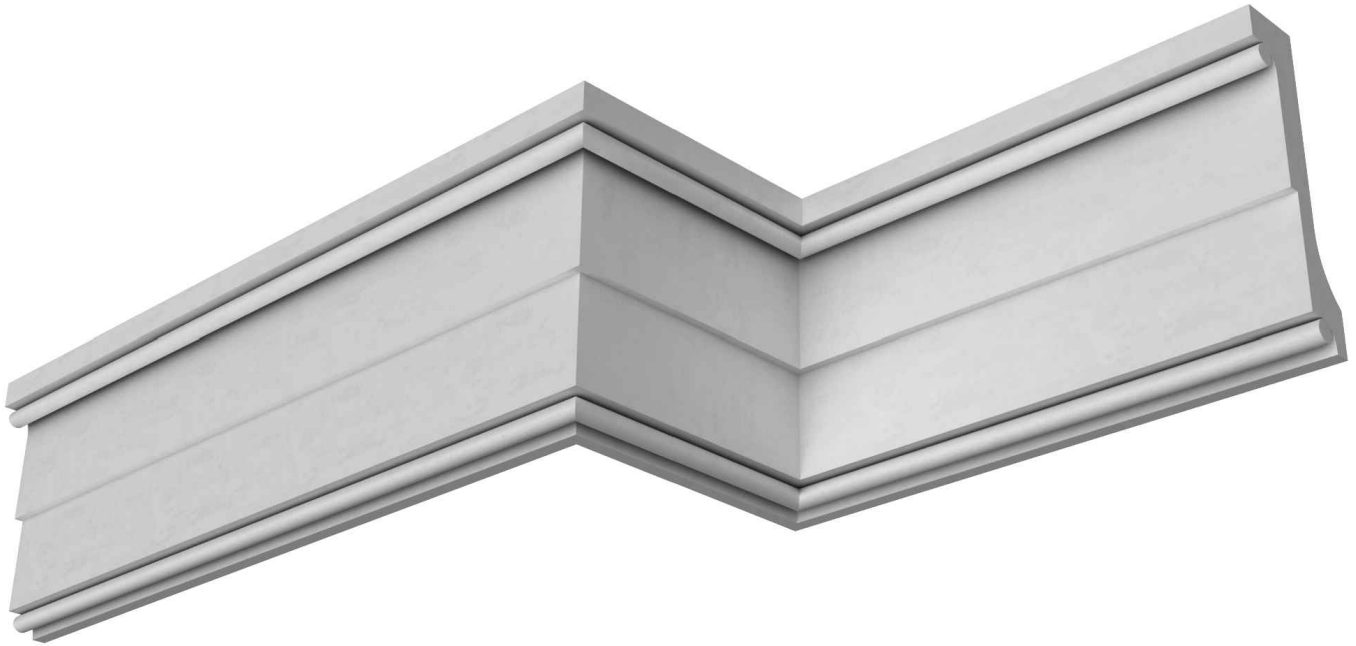

Part #: 30100  
Stepped Frieze





# CLASSIC MOULDINGS

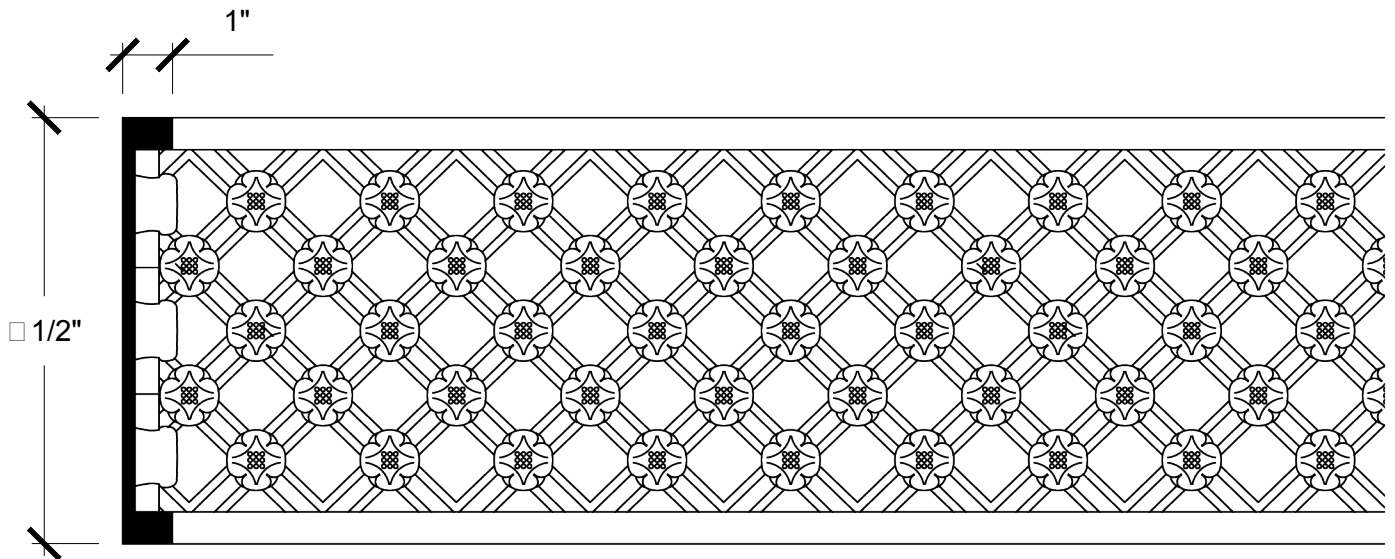

Part #: 30110

Frieze with Rosettes





# CLASSIC MOULDINGS

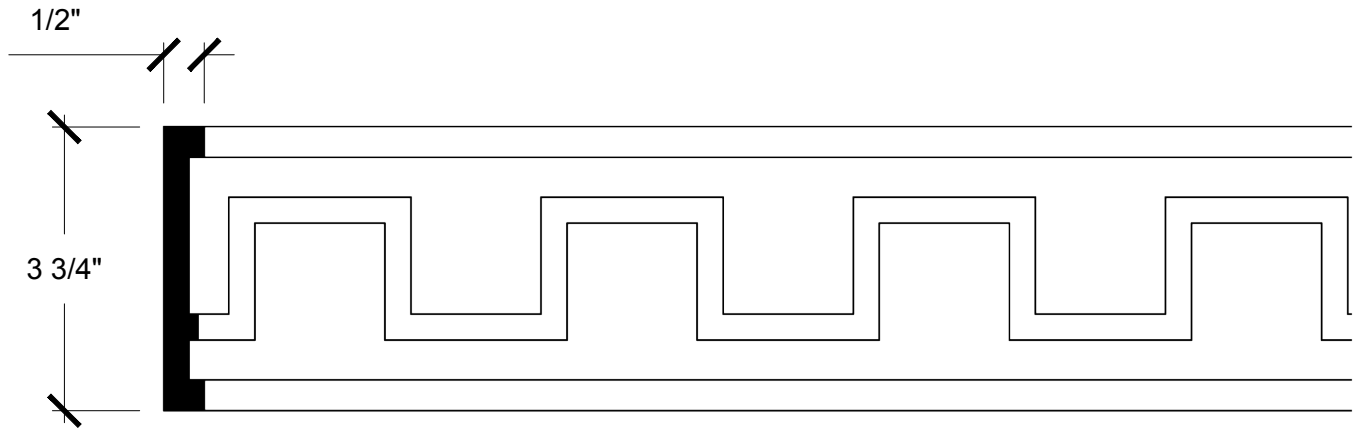
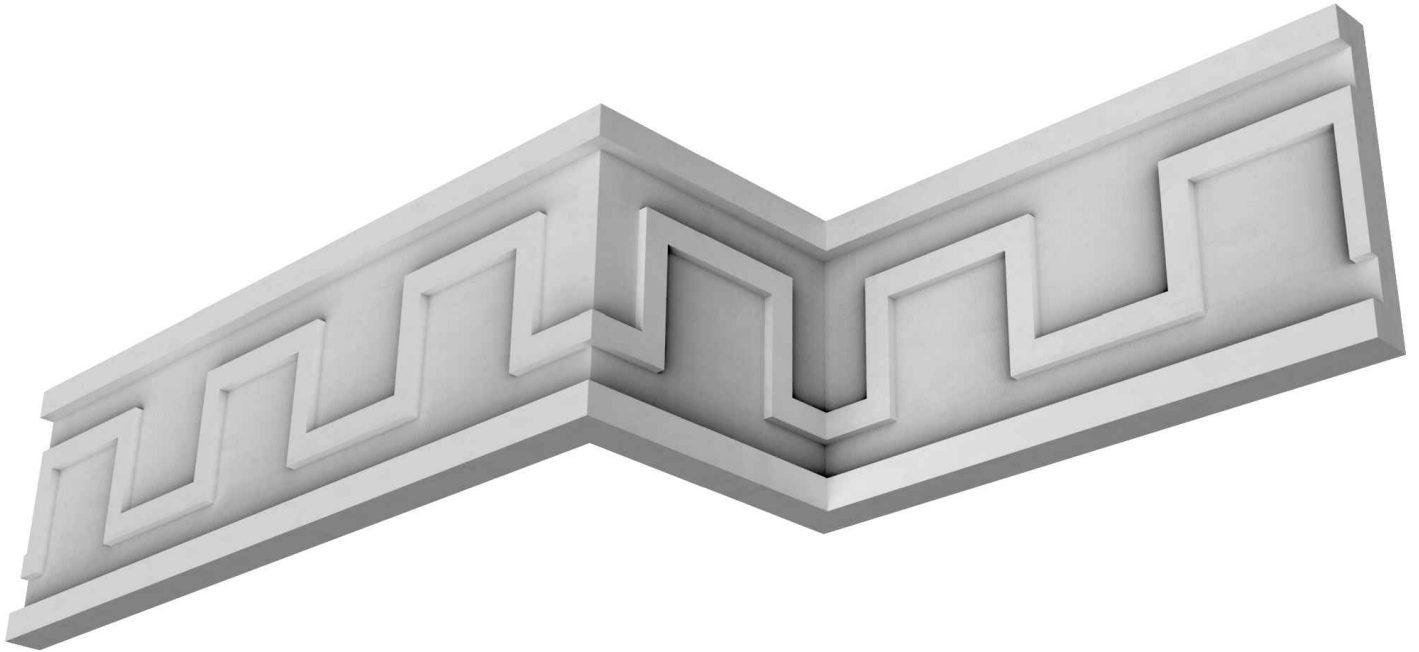

Part #: 340







# CLASSIC MOULDINGS

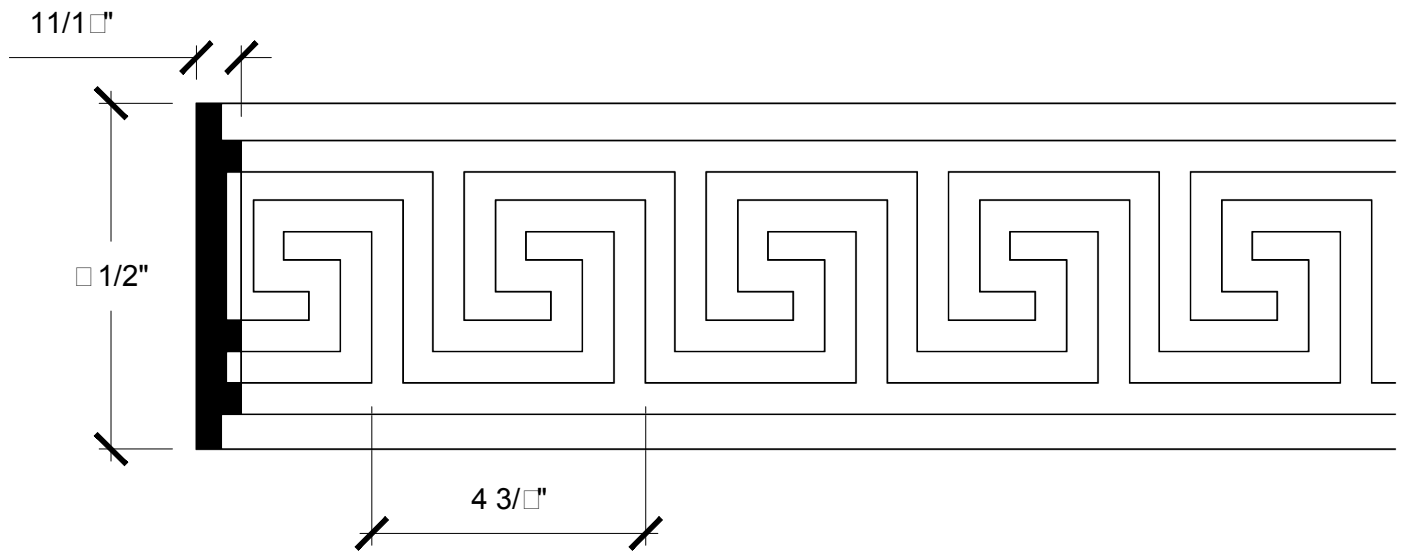
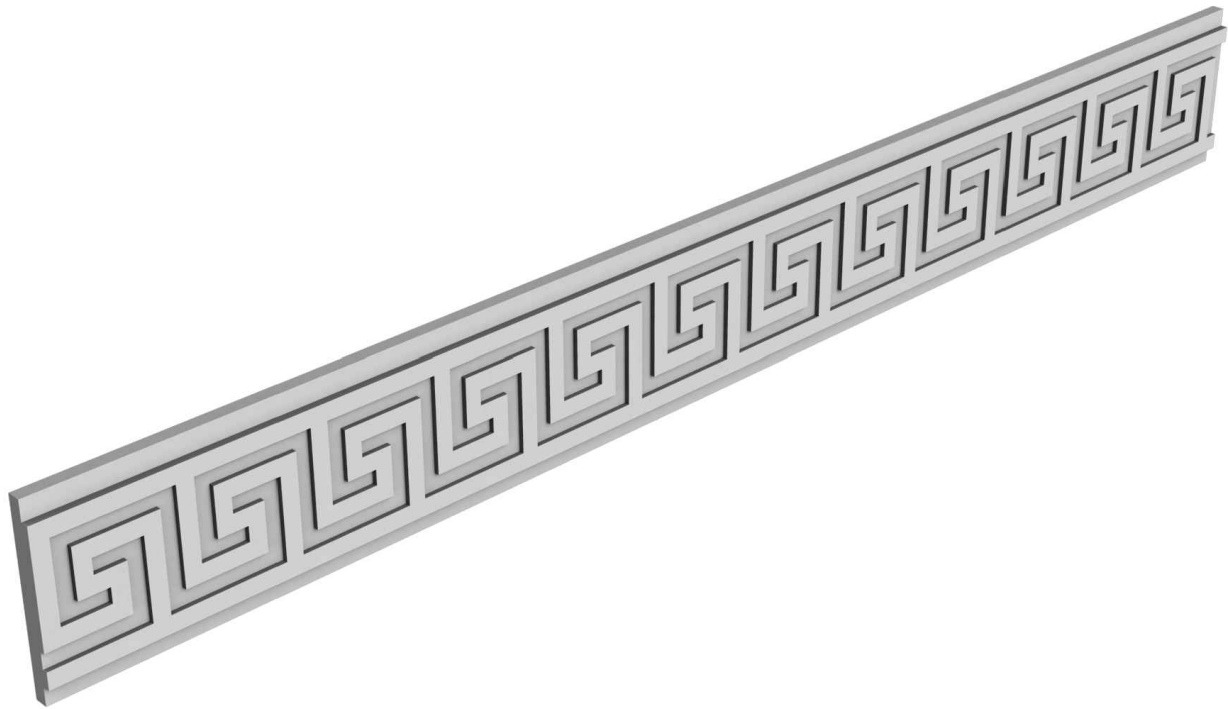

Part #: 342S



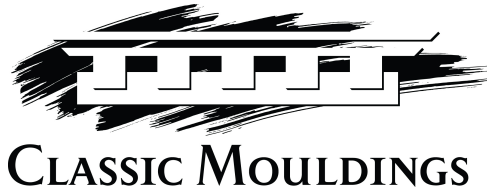

CLASSIC MOULDINGS

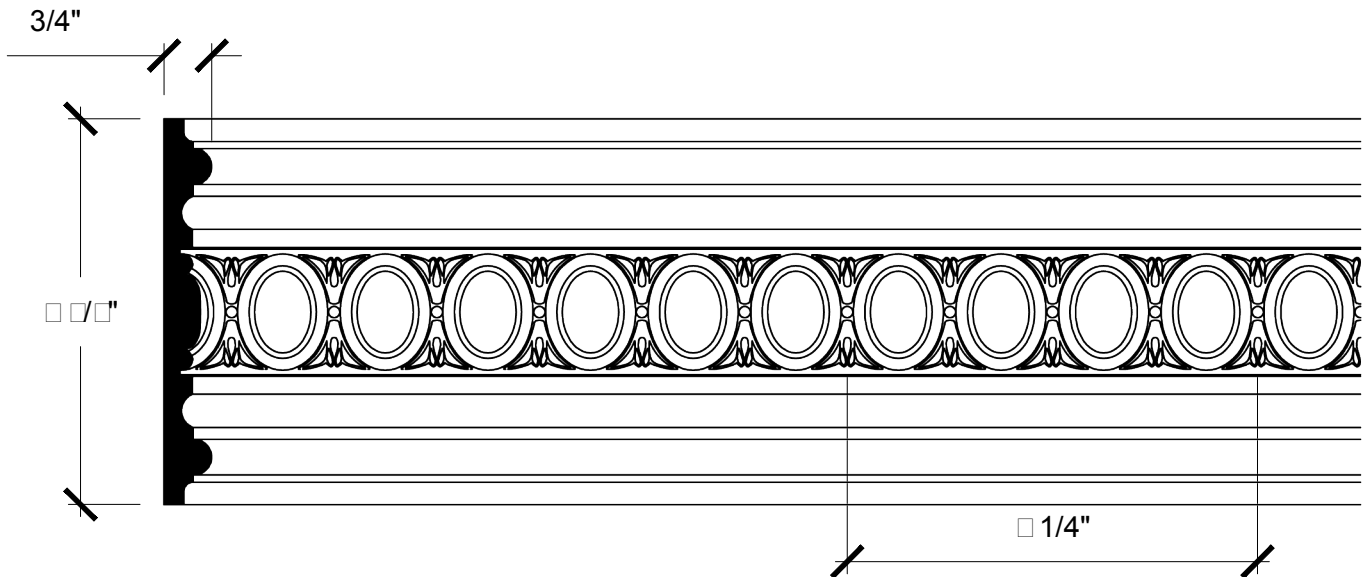
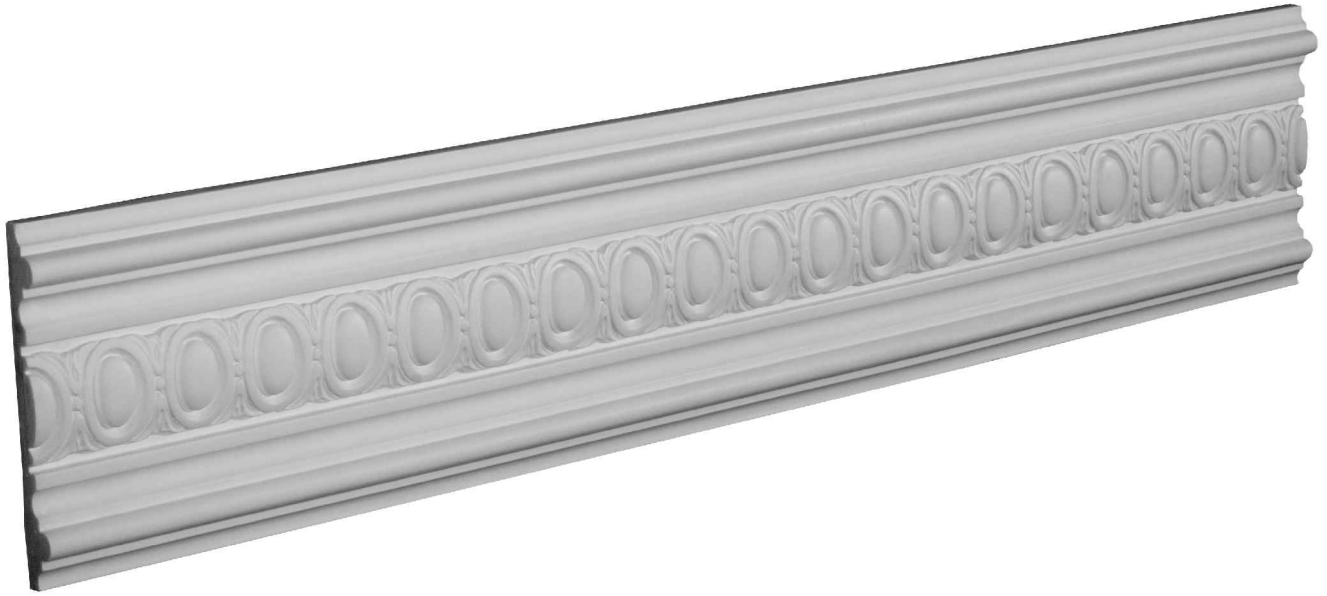

Part #: 477  
Cameo Panel Moulding





# CLASSIC MOULDINGS

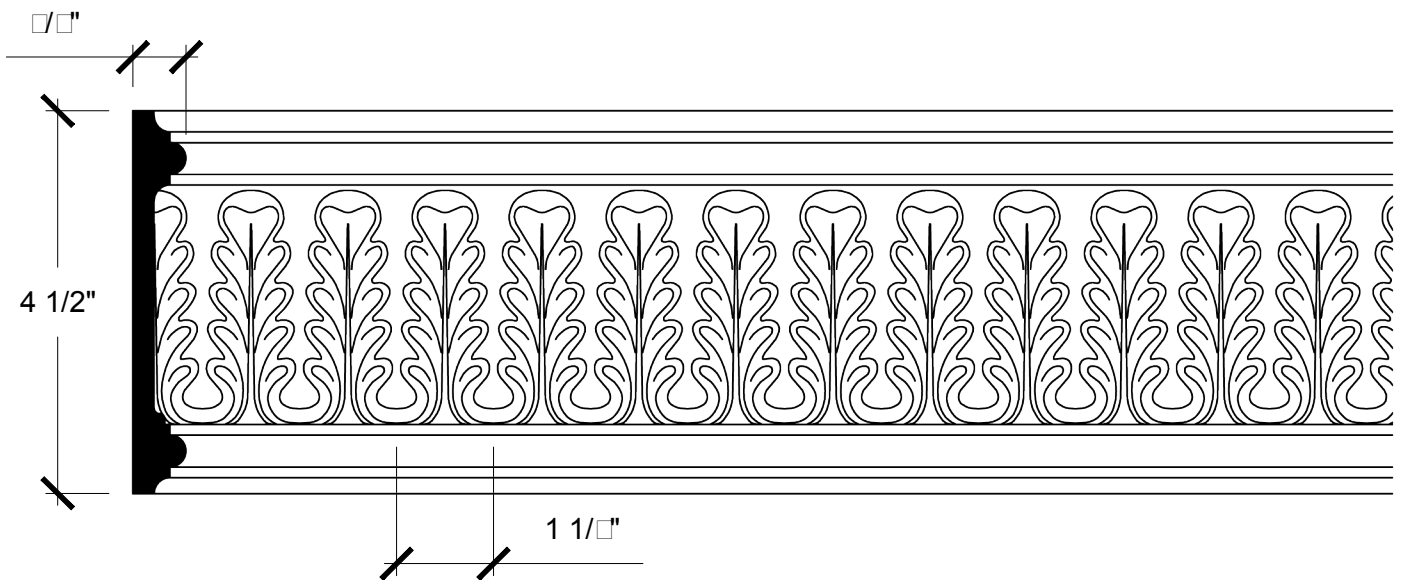
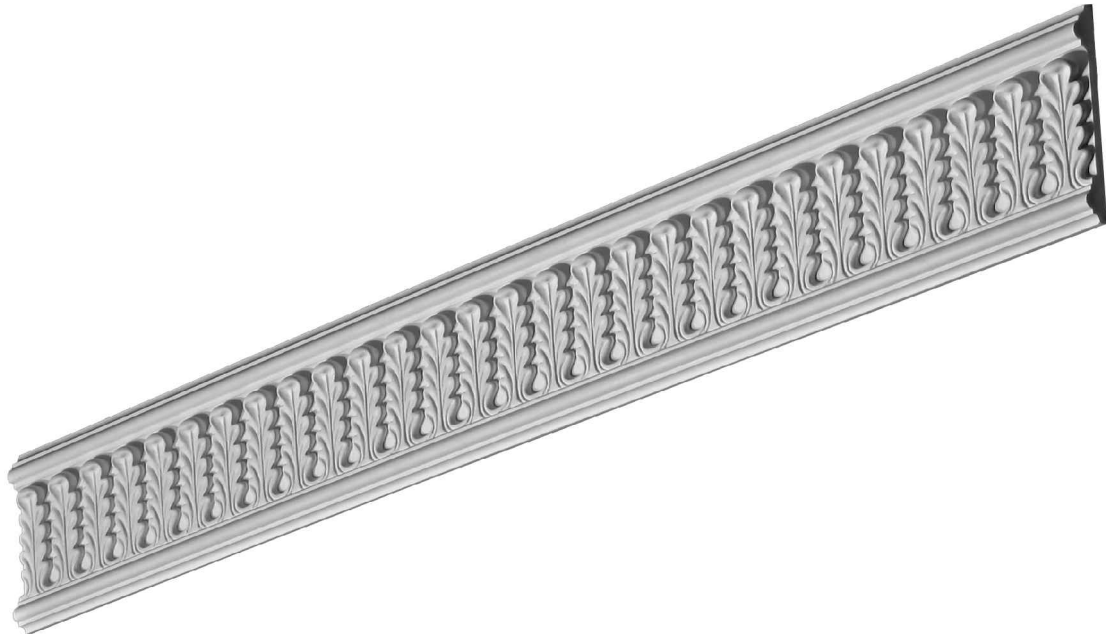

Part #: 447





# CLASSIC MOULDINGS

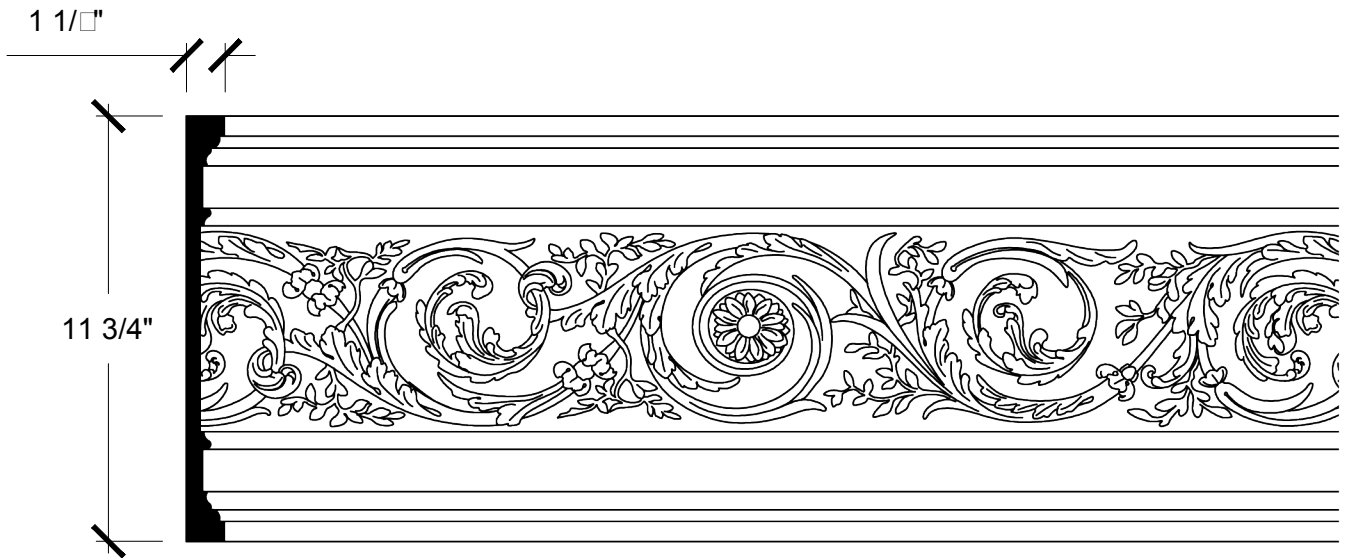

Part #: 461  
Decorative Leaf And Scroll Frieze





# CLASSIC MOULDINGS

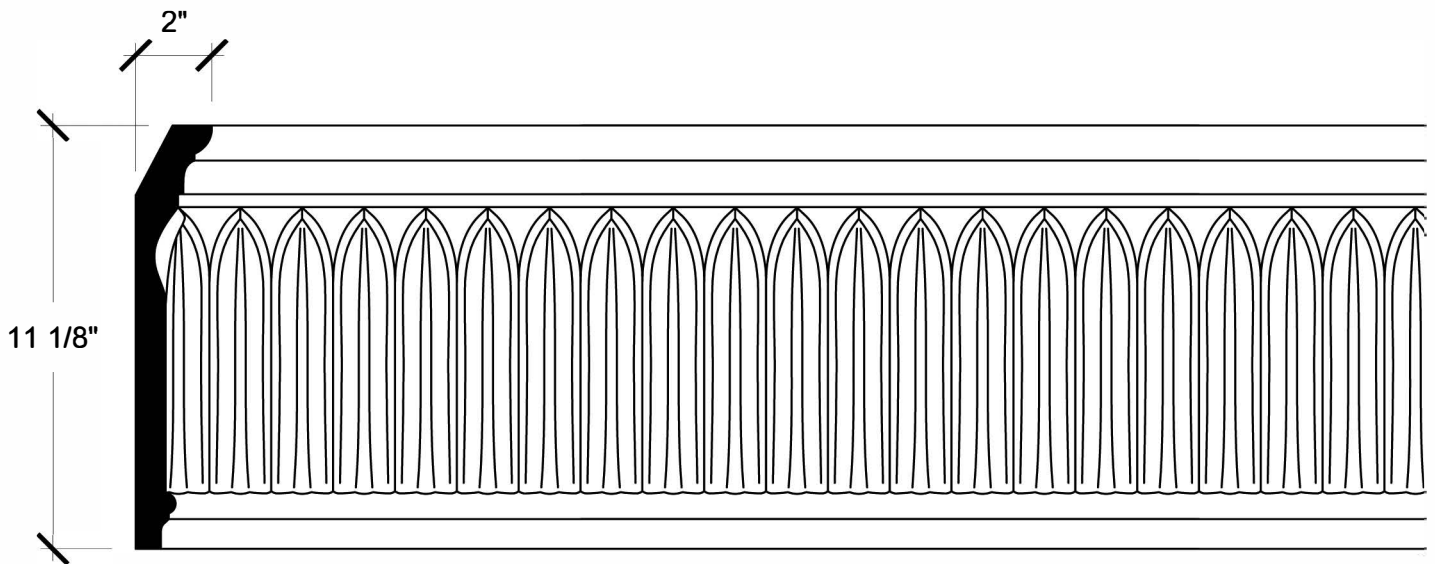
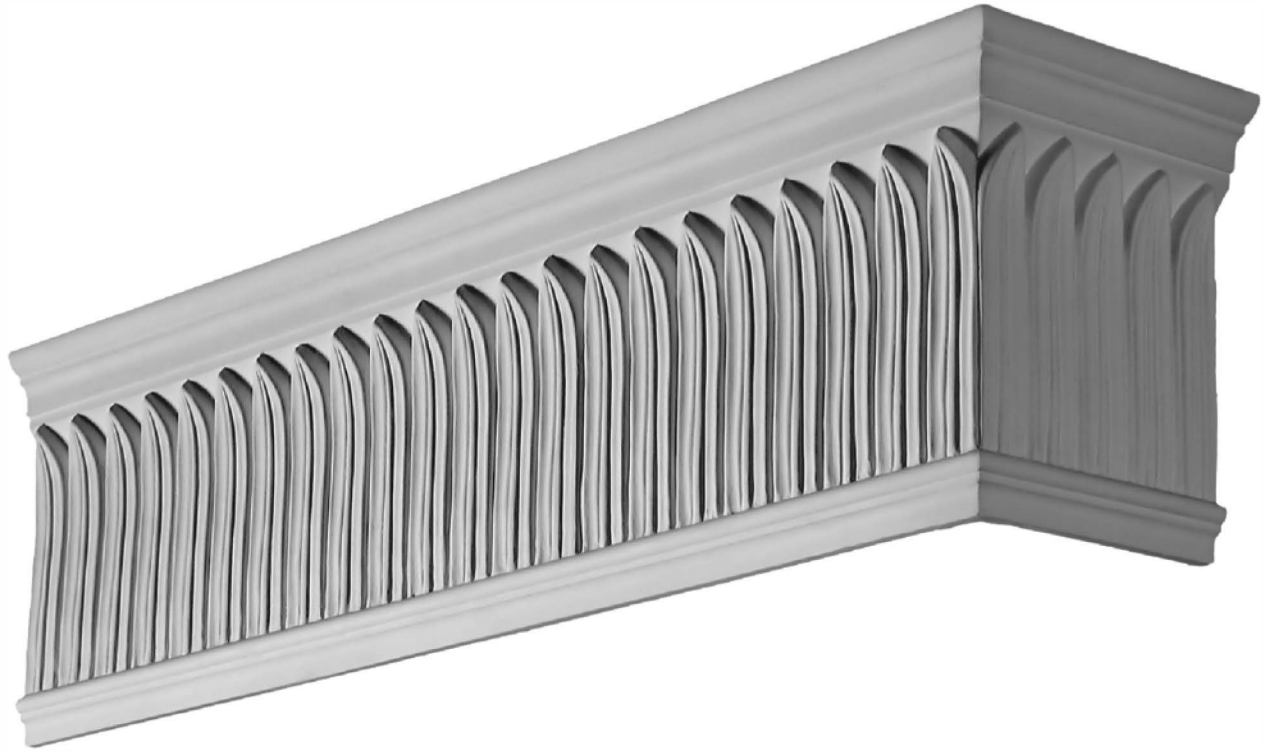

Part #: 600



# CLASSIC MOULDINGS

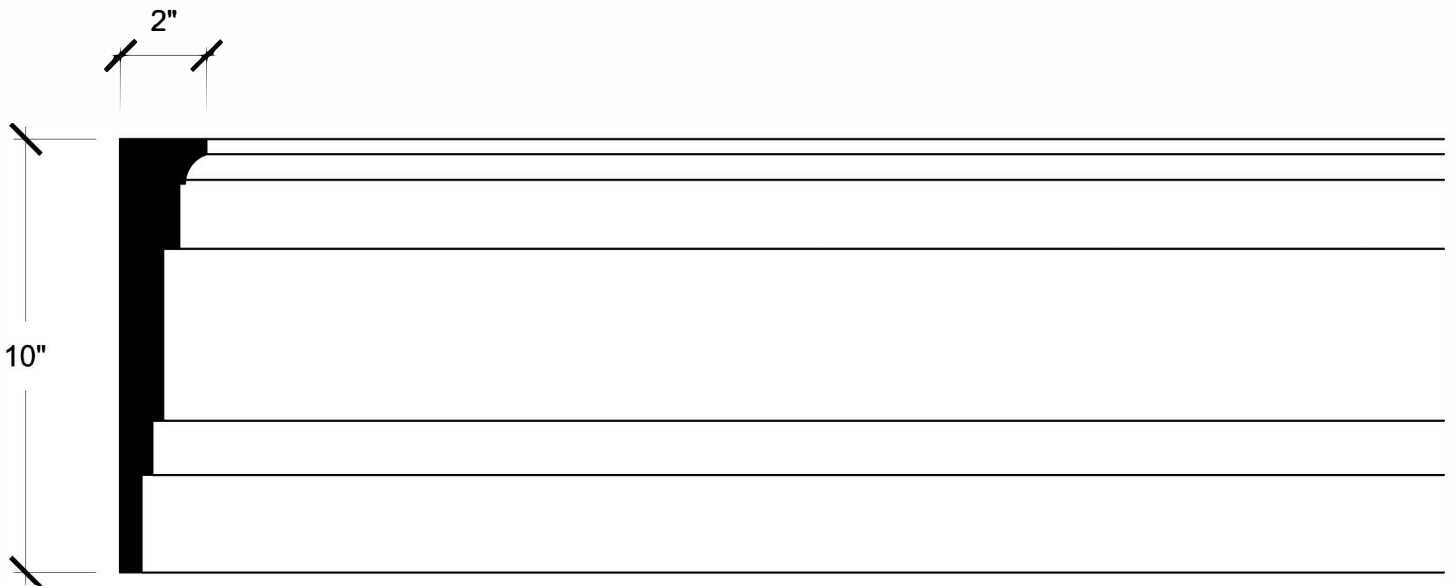
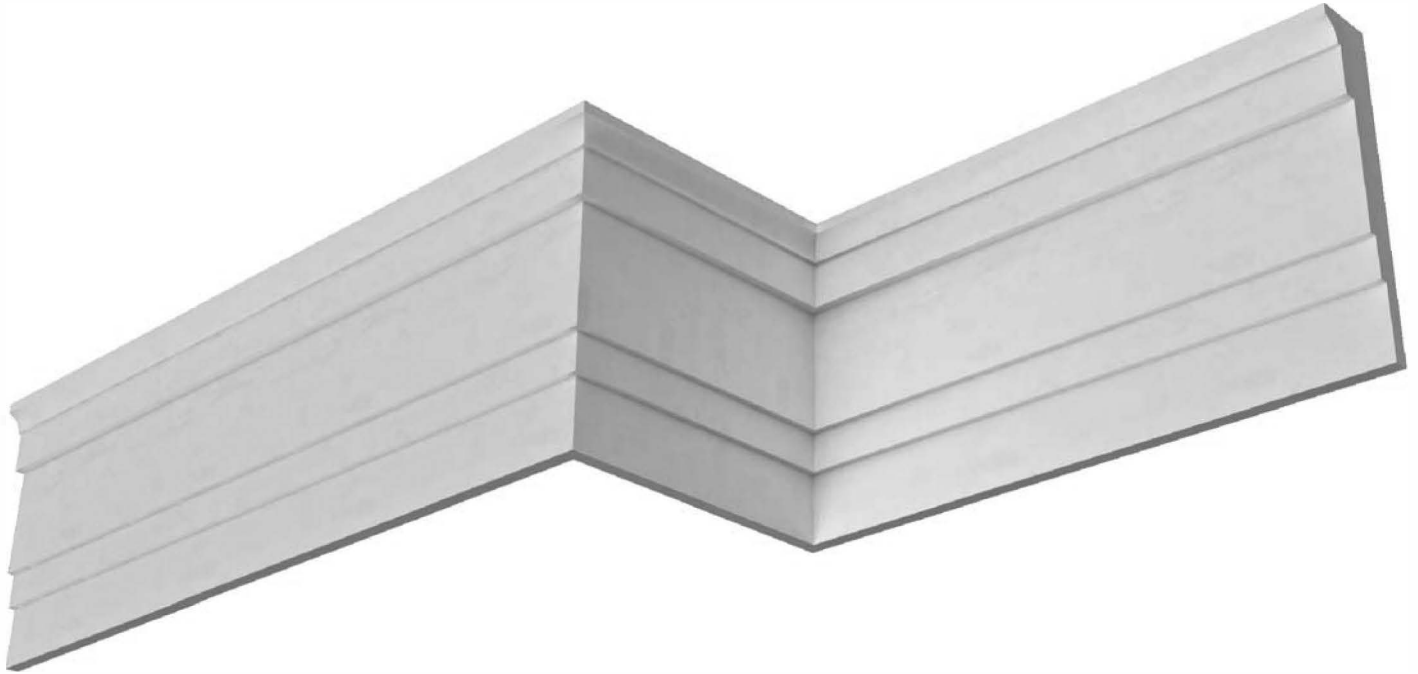

Part #: 36060

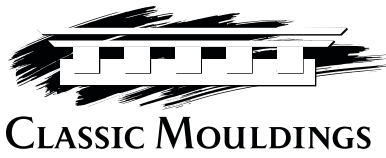

---

Canada  
Classic Mouldings Inc.  
226 Toryork Drive  
Toronto, Ontario M9L 1Y1

---

United States  
Classic Art Mouldings Inc.  
1010 Belvedere Road  
West Palm Beach, Florida 33405

---

Telephone: 416.745.5560  
Toll Free: 1-866-745-5560

*info@classicmouldings.com*

**classicmouldings.com**

---